

SPECIFICATIONS:

POSTS: GALVALUME™ COLD FORMED STEEL TUBING & PICKETS COATED INTERIOR & EXTERIOR

RAILS: ZAM™ COATED COLD FORMED TUBING (Zinc, Aluminum, Magnesium) COATED INTERIOR & EXTERIOR

FINISH: CHROMATE CONVERSION COATING ELECTROSTATICALLY APPLIED THERMALLY BONDED POLYESTER POWDER COATING MINIMUM FILM THICKNESS 2.5 mils

POSTS: 51mm x 51mm (2"x2"), 14 OR 16GA.
POST CAPS: PYRAMID, BALL, SPIRE OR ACORN

RAILS: 25mm x 25mm (1" x 1"), 14GA.

UPRIGHTS: 25mm x 25mm (1" x 1"), 16GA

PICKETS: 16mm x 16mm (5/8" x 5/8"), 18GA.

INFILL: 89mm SCROLLS

WELDS: STAINLESS STEEL

COLOUR: STANDARD COLOURS ARE BLACK, SEMI-BLACK BROWN, GREEN, WHITE AND FOREST GREEN (CUSTOM COLOURS AVAILABLE UPON REQUEST)

AVAILABLE GATE HEIGHTS:

762mm	(30")	
914mm	(36")	
1067mm	(42")	
1219mm	(48")	
1524mm	(60")	SHOWN
1829mm	(72")	

FITTINGS

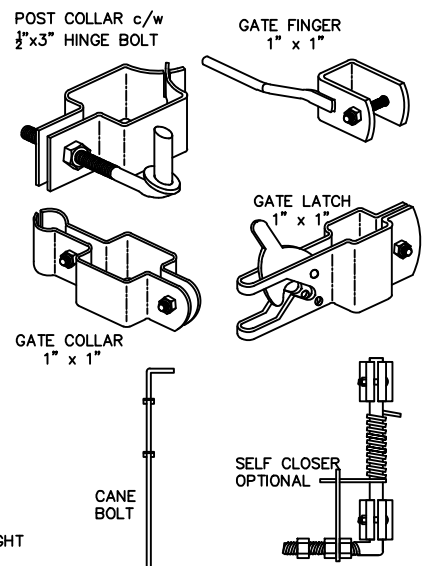

SECTION A-A

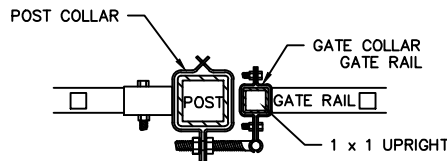

COMMENTS: DOUBLE SWING GATE



TITLE	IRON EAGLE I	DRAWING No.
	STYLE 2915 DOUBLE SWING GATE	2915-DG
	CHK'D	DATE: JAN 12, 2018